

1468 Stainless Steel Trailer Bracket

(for 1468-R & 1468-L)

Bolt Kit

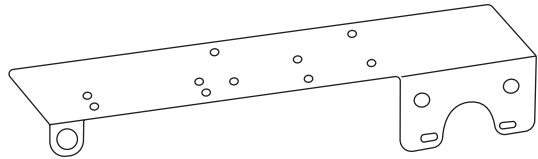

1 x Bracket



6 x Flange Nuts
(For Trailer Vision and
Camera Socket)

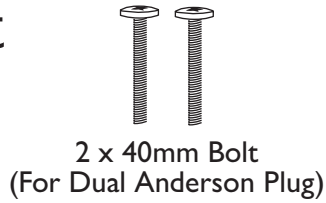

2 x 40mm Bolt
(For Dual Anderson Plug)

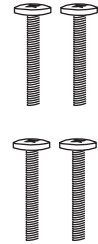

4 x 25mm Bolt
(For Single Anderson Plug
or Trailer Vision Anderson Plug)

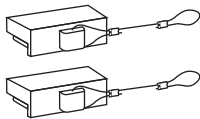

2 x Anderson Covers



4 x Nuts
(For Trailer Plug and
Anderson Plugs)

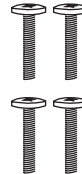

4 x 16mm M4 Bolt
(For Trailer Plug and
Camera Socket)

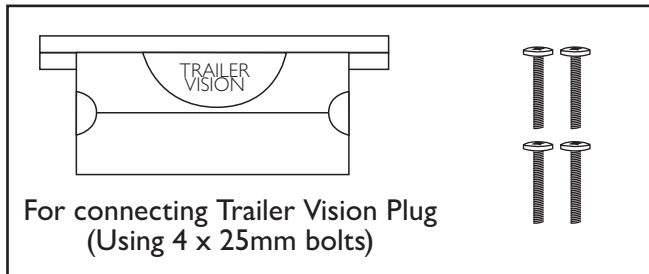

For connecting Trailer Vision Plug
(Using 4 x 25mm bolts)

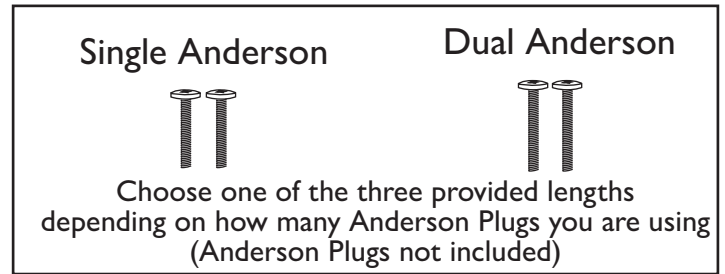

Single Anderson

Dual Anderson

Choose one of the three provided lengths
depending on how many Anderson Plugs you are using
(Anderson Plugs not included)

2 x 16mm M4 Bolts
for RIGHT mounting trailer plug
(two different mounting options)

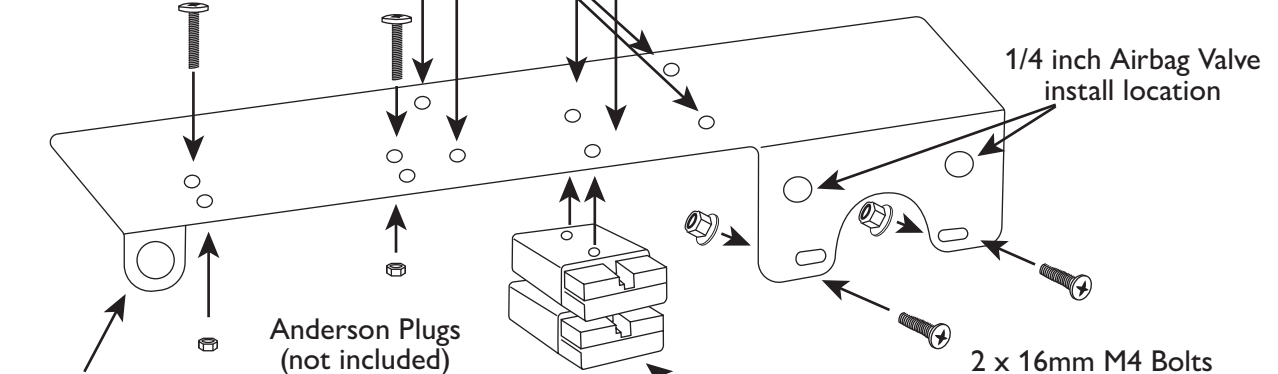

1/4 inch Airbag Valve
install location

Anderson Plugs
(not included)

You will need to widen the
standard holes to a 4mm hole

2 x 16mm M4 Bolts
for Apollo & Polaris
Caravan Camera Sockets

Please Note

DO NOT use Break Away loop if
the bracket is directly attached to
the Tow Bar.
An alternate Break Away location
will need to be used

Anderson Covers

(07) 3137 2727

SALES@ADVANCEDICE.COM.AU

WWW.ADVANCEDICE.COM.AU



/ADVANCEDICE1



/ADVANCEDICE

